

PERSONAL CARE PRODUCTS WORD SEARCH PUZZLE !

Find and circle the words in the word search puzzle and number the pictures

| | | | | | | | | | | | | | | |
|---|---|---|---|---|---|---|---|---|---|---|---|---|---|---|
| v | u | u | l | t | j | h | f | s | m | a | g | x | v | d |
| b | m | j | i | o | w | b | s | k | b | a | m | y | d | e |
| z | r | t | p | o | s | h | o | w | e | r | g | e | l | o |
| j | r | o | b | t | h | a | n | p | s | j | y | c | q | d |
| l | v | o | a | h | i | n | c | e | l | h | t | s | t | o |
| m | t | t | l | p | s | d | b | r | g | a | d | h | w | r |
| o | s | h | m | a | q | l | e | f | v | i | j | a | u | a |
| u | h | b | j | s | u | o | a | u | m | r | l | m | r | n |
| t | v | r | c | t | v | t | i | m | i | s | g | p | a | t |
| h | j | u | d | e | j | i | l | e | r | p | n | o | z | a |
| w | f | s | x | n | x | o | e | s | r | r | m | o | o | c |
| a | s | h | a | v | i | n | g | f | o | a | m | c | r | d |
| s | s | p | o | n | g | e | h | b | r | y | z | x | k | r |
| h | d | e | n | t | a | l | f | l | o | s | s | l | a | j |
| w | w | r | v | d | s | u | n | s | c | r | e | e | n | s |

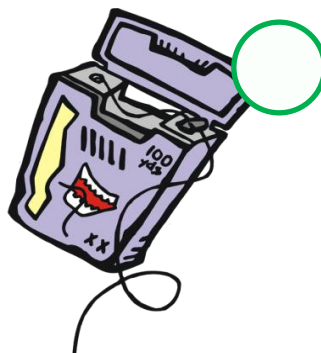
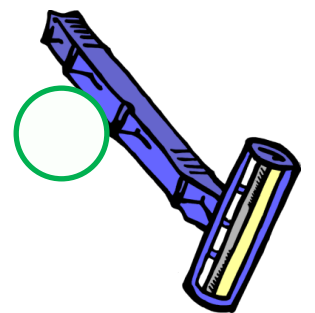
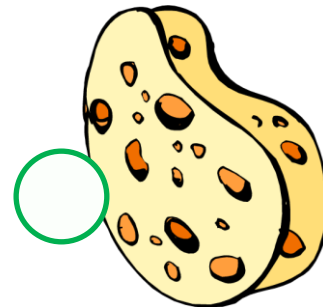
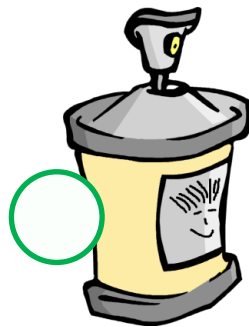
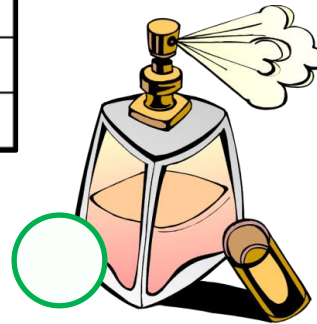
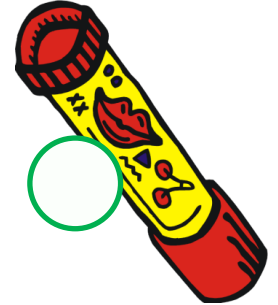

1. perfume
2. deodorant
3. hand lotion
4. mirror
5. mouthwash
6. dental floss
7. toothbrush
8. toothpaste
9. lip balm
10. razor
11. shaving foam
12. shampoo
13. shower gel
14. sponge
15. sunscreen
16. hair spray

PERSONAL CARE PRODUCTS WORD SEARCH PUZZLE 2

Find and circle the words in the word search puzzle and number the pictures

| | | | | | | | | | | | | | | |
|---|---|---|---|---|---|---|---|---|---|---|---|---|---|---|
| k | u | c | o | t | t | o | n | b | u | d | c | a | g | u |
| m | x | s | h | a | i | r | b | r | u | s | h | o | o | u |
| n | k | u | t | i | s | s | u | e | s | s | s | w | u | w |
| a | t | n | u | w | j | e | t | f | s | x | g | k | c | s |
| i | p | g | f | b | q | e | w | m | v | h | h | f | l | c |
| l | a | l | a | h | h | n | e | y | d | a | d | u | v | i |
| f | p | a | c | c | a | p | e | t | x | i | w | e | d | s |
| i | e | s | i | k | i | u | z | b | n | r | o | o | s | s |
| l | r | s | a | i | r | a | e | v | s | d | o | x | x | o |
| e | t | e | l | e | c | t | r | i | c | r | a | z | o | r |
| u | o | s | m | z | l | c | s | k | w | y | q | d | e | s |
| z | w | b | a | z | i | o | z | g | m | e | g | y | x | w |
| c | e | e | s | g | p | m | h | a | i | r | b | a | n | d |
| u | l | x | k | m | s | b | i | k | s | c | a | l | e | s |
| e | n | a | i | l | c | l | i | p | p | e | r | s | n | w |

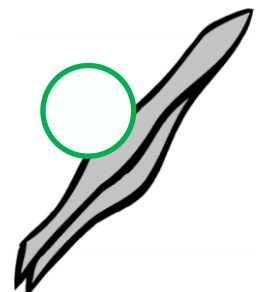
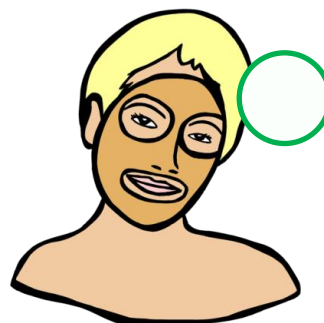
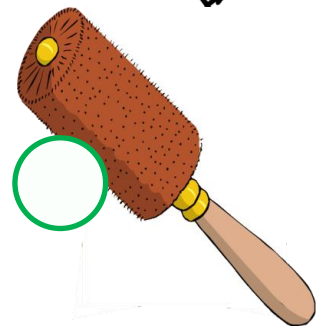
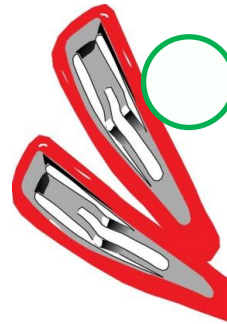
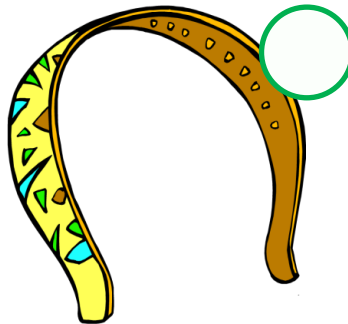
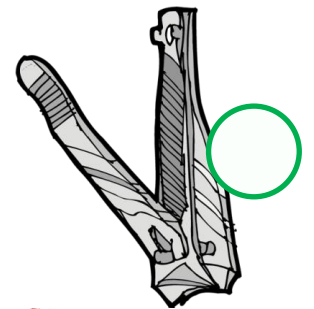
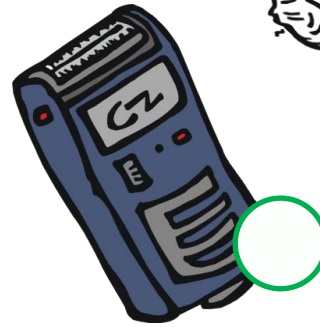
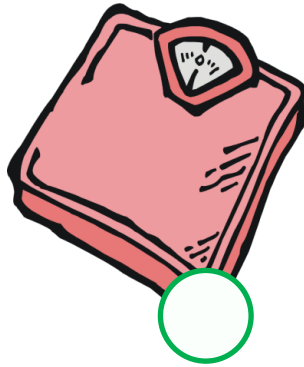
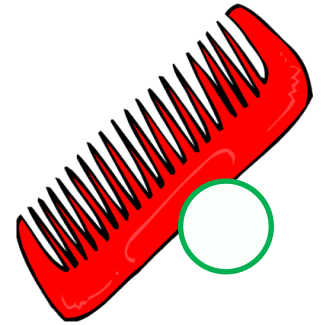
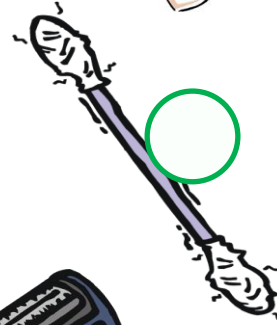
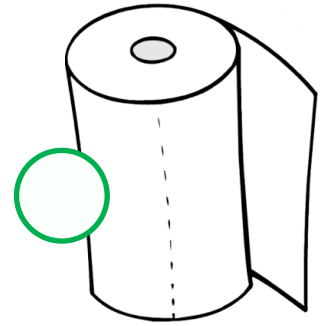
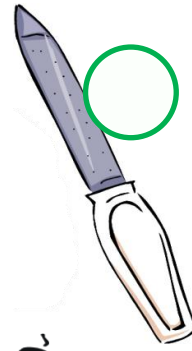
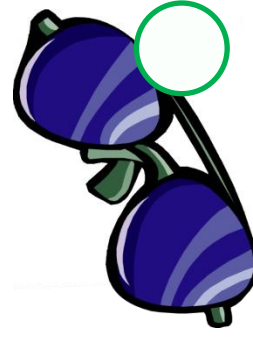

1. electric razor
2. hair dryer
3. hairbrush
4. scissors
5. comb
6. tweezers
7. nail clippers
8. nail file
9. paper towel
10. tissues
11. cotton bud
12. hairband
13. scales
14. sunglasses
15. hair clips
16. facial mask

PERSONAL CARE PRODUCTS WORD SEARCH PUZZLE | ANSWER KEY

Find and circle the words in the word search puzzle and number the pictures

| | | | | | | | | | | | | | | |
|---|---|---|---|---|---|---|---|---|---|---|---|---|---|---|
| v | u | u | l | t | j | h | f | s | m | a | g | x | v | d |
| b | m | j | i | o | w | b | s | k | b | a | m | y | d | e |
| z | r | t | p | o | s | h | o | w | e | r | g | e | l | o |
| j | r | o | b | t | h | a | n | p | s | j | y | c | q | d |
| l | v | o | a | h | i | n | c | e | l | h | t | s | t | o |
| m | t | t | l | p | s | d | b | r | g | a | d | h | w | r |
| o | s | h | m | a | q | l | e | f | v | i | j | a | u | a |
| u | h | b | j | s | u | o | a | u | m | r | l | m | r | n |
| t | v | r | c | t | v | t | i | m | i | s | g | p | a | t |
| h | j | u | d | e | j | i | l | e | r | p | n | o | z | a |
| w | f | s | x | n | x | o | e | s | r | r | m | o | o | c |
| a | s | h | a | v | i | n | g | f | o | a | m | c | r | d |
| s | s | p | o | n | g | e | h | b | r | y | z | x | k | r |
| h | d | e | n | t | a | l | f | l | o | s | s | l | a | j |
| w | w | r | v | d | s | u | n | s | c | r | e | e | n | s |

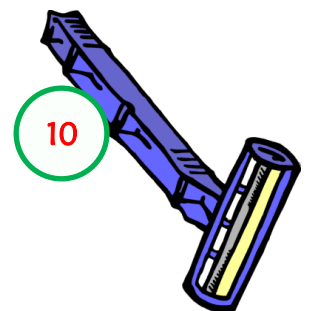
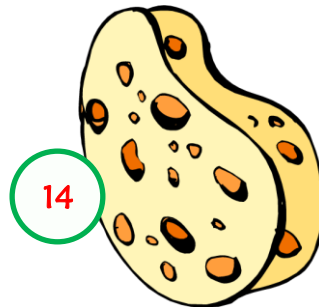
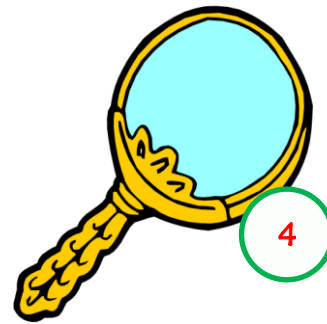
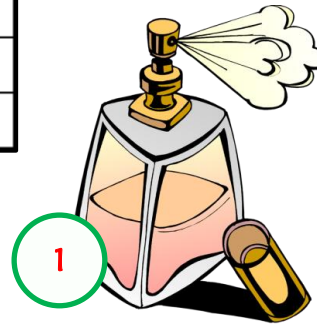

1. perfume
2. deodorant
3. hand lotion
4. mirror
5. mouthwash
6. dental floss
7. toothbrush
8. toothpaste
9. lip balm
10. razor
11. shaving foam
12. shampoo
13. shower gel
14. sponge
15. sunscreen
16. hair spray

PERSONAL CARE PRODUCTS WORD SEARCH PUZZLE 2 ANSWER KEY

Find and circle the words in the word search puzzle and number the pictures

| | | | | | | | | | | | | | | |
|---|---|---|---|---|---|---|---|---|---|---|---|---|---|---|
| k | u | c | o | t | t | o | n | b | u | d | c | a | g | u |
| m | x | s | h | a | i | r | b | r | u | s | h | o | o | u |
| n | k | u | t | i | s | s | u | e | s | s | s | w | u | w |
| a | t | n | u | w | j | e | t | f | s | x | g | k | c | s |
| i | p | g | f | b | q | e | w | m | v | h | h | f | l | c |
| l | a | l | a | h | h | n | e | y | d | a | d | u | v | i |
| f | p | a | c | c | a | p | e | t | x | i | w | e | d | s |
| i | e | s | i | k | i | u | z | b | n | r | o | o | s | s |
| l | r | s | a | i | r | a | e | v | s | d | o | x | x | o |
| e | t | e | l | e | c | t | r | i | c | r | a | z | o | r |
| u | o | s | m | z | l | c | s | k | w | y | q | d | e | s |
| z | w | b | a | z | i | o | z | g | m | e | g | y | x | w |
| c | e | e | s | g | p | m | h | a | i | r | b | a | n | d |
| u | l | x | k | m | s | b | i | k | s | c | a | l | e | s |
| e | n | a | i | l | c | l | i | p | p | e | r | s | n | w |

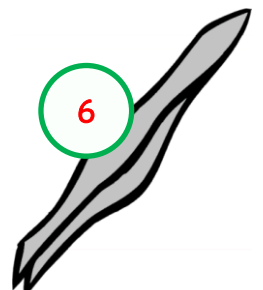
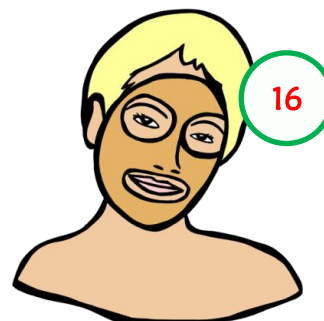
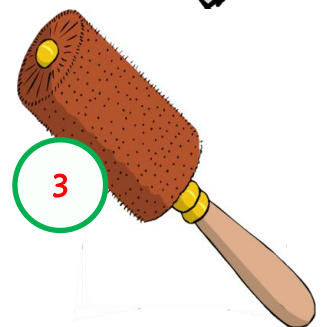
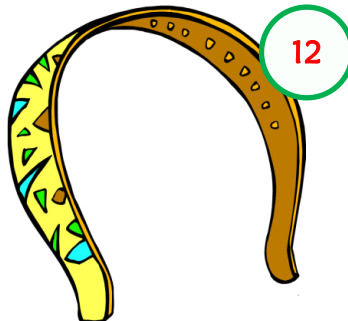
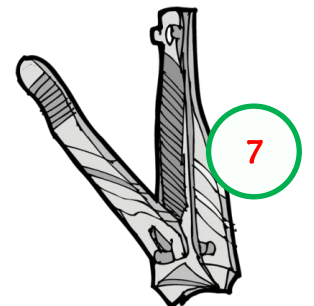
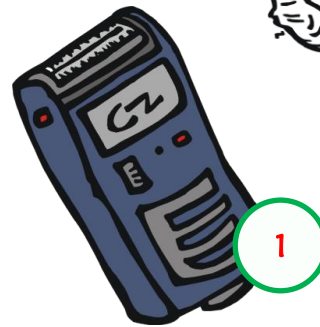
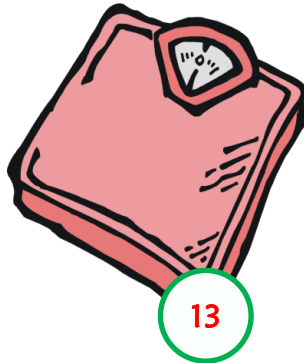
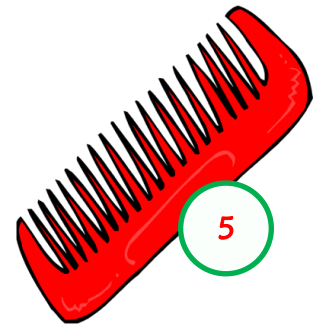
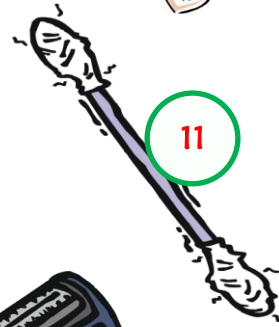
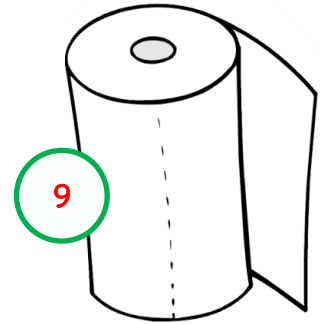
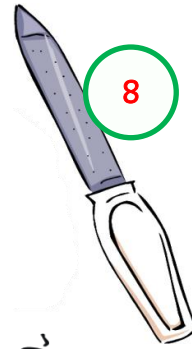
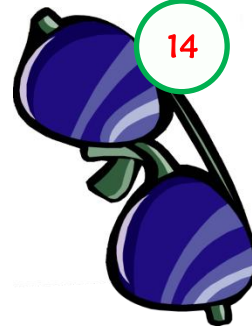

1. electric razor
2. hair dryer
3. hairbrush
4. scissors
5. comb
6. tweezers
7. nail clippers
8. nail file
9. paper towel
10. tissues
11. cotton bud
12. hairband
13. scales
14. sunglasses
15. hair clips
16. facial mask

